

ZETA 2.3"-Surface Mount

Spec-grade | Architectural LED Linear Lighting



OKT ZETA series 2.3" linear surface lighting is a unique linear series that brings any space to the center stage. These timeless, streamlined forms blend well with contemporary decors and modern workplaces. These linear luminaries is available in 2ft, 3ft, 4ft and 8ft, simply provide wide, powerful lighting to any atmosphere with continuous runs. Unleash lighting design flexibility with ZETA with different shapes and patterns, it adds fun factor into each room. These creations will let you suggest rhythm, communicate meaning and showcase element of life.

Feature

- Wattage selectable (50%/75%/100%)
- CCT adjustable from 3000K, 3500K, 4000K
- Individual units or continuous runs
- Available in diffuser, micro reflector, louver and regressed lens
- Custom pattern with optional Line and Illuminated L joiners.
- Available in 2ft, 3ft, 4ft and 8ft, up to 1000lm/ft

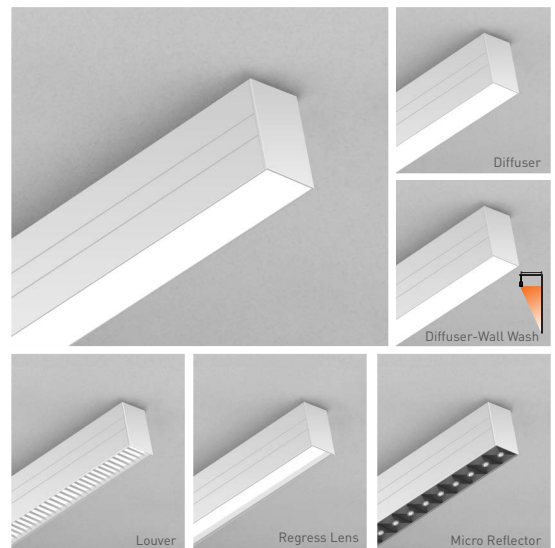

PERFORMANCE

Lens	Length	Wattage Selectable	100%DOWN		CCT Adjustable
			Efficacy	Lumen Output	
Diffuser	2'	20W/15W/10W	1050m/ft	Up to 2100LM	3000K/3500K/4000K
	3'	30W/23W/15W		Up to 3150LM	
	4'	40W/30W/20W		Up to 4200LM	
	8'	80W/60W/40W		Up to 8400LM	
Regressed Lens	2'	20W/15W/10W	900lm/ft	Up to 1800LM	3000K/3500K/4000K
	3'	30W/23W/15W		Up to 2700LM	
	4'	40W/30W/20W		Up to 3600LM	
	8'	80W/60W/40W		Up to 7200LM	
Louver	2'	20W/15W/10W	650m/ft	Up to 1300LM	3000K/3500K/4000K
	3'	30W/23W/15W		Up to 1950LM	
	4'	40W/30W/20W		Up to 2600LM	
	8'	80W/60W/40W		Up to 5200LM	
Micro Reflector	2'	20W/15W/10W	900lm/ft	Up to 1800LM	3000K/3500K/4000K
	3'	30W/23W/15W		Up to 2700LM	
	4'	40W/30W/20W		Up to 3600LM	
	8'	80W/60W/40W		Up to 7200LM	

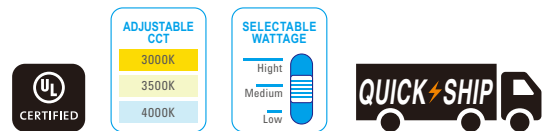

Remark:
Lumens are subject to maximum wattage, 4000K with white finish only.

Lumen output may vary ± 5% base on different CCT and wattage. Actual wattage may vary ± 5%.

ZETA 2.3"-Surface Mount

Spec-grade | Architectural LED Linear Lighting



PRODUCT ORDERING GUIDE

Example: ZE4B-WH-40W-D10-80TW-D-DF (Surface)

Default Settings: Maximum wattage, 4000K and 100% down.

ZE					80	TW	D		(Surface)
Product Series	Length	Finish	Wattage	0-10V Dim	CRI	CCT	Lighting Distribution	Down Lens	Just to remark the mounting. Don't show in product label.
ZE ZETA Linear	2B QuickShip 2 Feet Bold	WH QuickShip White	20W QuickShip 20W/15W/10W Selectable for 2ft	D10 QuickShip 110-277V AC Dims to 10% Tested Dimmers: Lutron® Diva-Dvtv, Leviton® IP-710-DL.	80 QuickShip 80+ CRI (Standard)	TW QuickShip CCT adjustable 3000K/3500K/ 4000K	D QuickShip 100% downtight	DF QuickShip Diffuser	
	3B QuickShip 3 Feet Bold	BL QuickShip Black	30W QuickShip 30W/23W/15W Selectable for 3ft	90 QuickShip 90+ CRI*				LV QuickShip Louver	
	4B QuickShip 4 Feet Bold	CM Custom *	40W QuickShip 40W/30W/20W Selectable for 4ft	D01 110-277V AC Dim to 1%*				MR QuickShip Micro Reflector	
	8B 8 Feet Bold*		80W 80W/60W/40W Selectable for 8ft*					RL QuickShip Regressed Lens (White)	
								WW QuickShip Wall Wash Diffuser (30° Tilt)	

Note: UL Listed Model#s have been updated. The actual product label may appear to be different than actual specsheet.

OPTIONAL ACCESSORY

Lit Joiner		Mounting & Optional Function	
SJ QuickShip Straight Line Joiner (Optional 40' rolling lens)	 SJ Line Joiner	SMK QuickShip Surface Mounting Kits	
LJ QuickShip Lit "L" Joiner	 LJ "L" Joiner	EME QuickShip Emergency Function (Only external 8w or 25w LED emergency driver with standard indicator available and need field-installed.)	

CUSTOM LINE OR SHAPE ORDERING GUIDE

Example: ZEBD-S-S08-WH-DF-D10

SHAPE/LENGTH* (CHOOSE 1 & ENTER LENGTH IN FEET)	Finish	Down Lens	0-10V Dim
ZEBD-S-C ___ Individual 6ft/ up to 8ft Continuous Run Section QuickShip (Enter length in product code above, ex. C18)	WH QuickShip White	DF QuickShip Diffuser	D10 QuickShip 110-277V AC Dims to 10% Tested Dimmers: Lutron® Diva-Dvtv, Leviton® IP-710-DL.
ZEBD-S-S ___ Square Configuration (Enter side length A, ex: S18) QuickShip	BL QuickShip Black	LV QuickShip Louver	
ZEBD-S-R ___/___ Rectangular Configuration (Enter side lengths A and B, ex. R12/24) QuickShip	CM Custom *	MR QuickShip Micro Reflector	D01 110-277V AC Dim to 1%*
ZEBD-S-L ___/___ L-Shaped Configuration (Enter side lengths A and B, ex. L12/24) QuickShip		RL QuickShip Regressed Lens (White)	
		WW QuickShip Wall Wash Diffuser (30° Tilt)	

A
(C)
Continuous Run

A
(S)
Square

A B
(R)
Rectangular

A B
(L)
L-Shaped

Shape orientation Looking from the Ceiling down to the floor.
All corners of shape must be 90° or 120°, same plane. joiners and rolling lens will be included.
FOR more complex shape, CONTACT OKT.

* Means additional cost and/or lead time on customized fixtures may apply. Some fixtures require an MOQ. Please contact your sales rep for more information.

Damp rated for ambient operating temperature of -20°C to +40°C (-4° to +104°F)

ZETA 2.3"-Surface Mount

Spec-grade | Architectural LED Linear Lighting



MOUNTING LOCATION

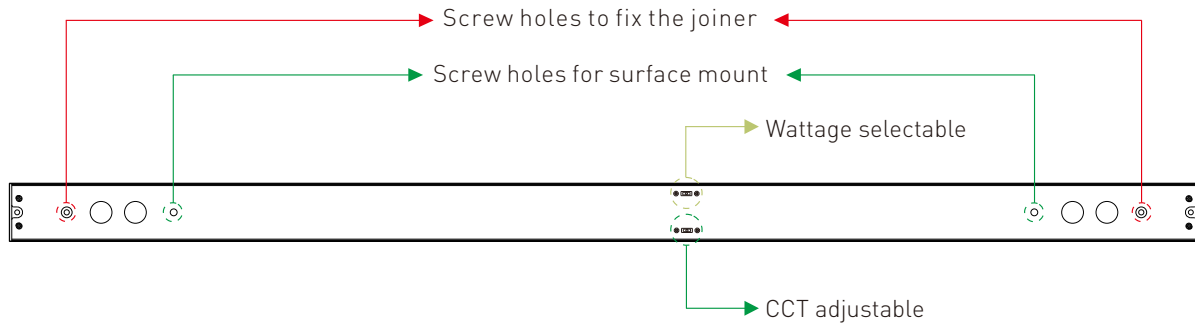

DIMENSIONS

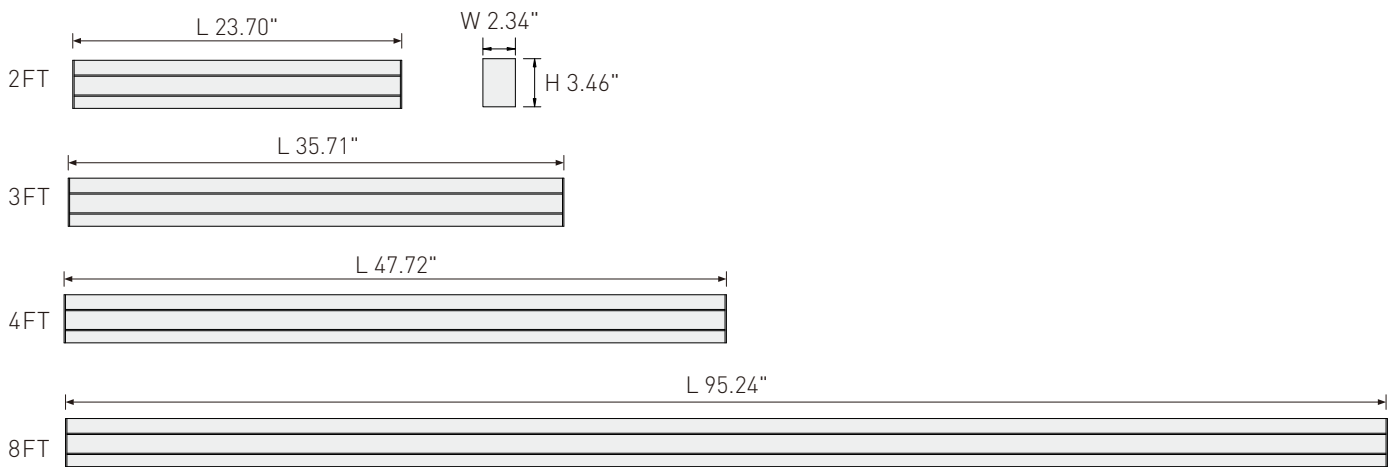

OPTIONAL FUNCTION

► Emergency Option

OKT Lighting offers UL & CEC Listed LED emergency drivers. When AC power fails it, immediately switches to the emergency mode operating for lighting minimum 90 minutes. When AC power is restored it, automatically returns to the charging mode which meets critical life-safety lighting requirements.

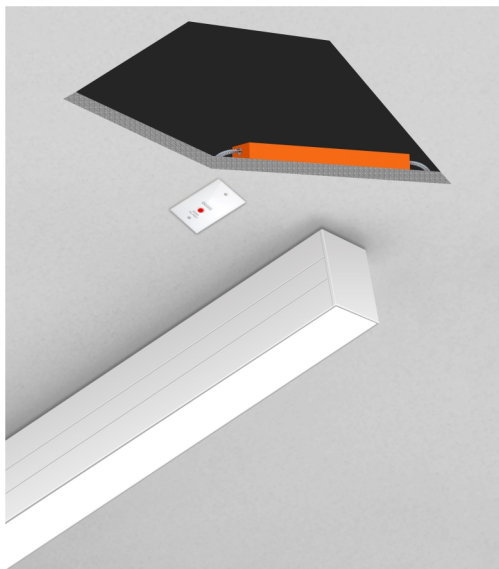

EME

Order Separated LED emergency driver

Optional 8w or 25w high voltage LED emergency driver can be provided if you need and do it wiring in field. For more info or spec sheet please visit our website or contact sales.



Code-Required Testing

• Initial Self-Test After Installation

It will perform a functional test in 3 seconds after the driver installed to check the wiring and battery output when work. The indicator LED will be off or flicker in case of a failure or an error.

• Second Self-Test In 120 Minutes

It will perform second test in 120 minutes to check again. Upgrade in Gen 3: Repeat 4 times in every 120 minutes if fail in the second test.

• Monthly Self-Test

It will automatically perform a test every 30 days with a duration of 3 seconds, in which the wiring and battery output are checked. In case of a failure or an error, the indicator LED will be off or flicker.

ZETA 2.3"-Surface Mount

Spec-grade | Architectural LED Linear Lighting



DISTRIBUTION DIAGRAM

4' / Diffuser / 3500K

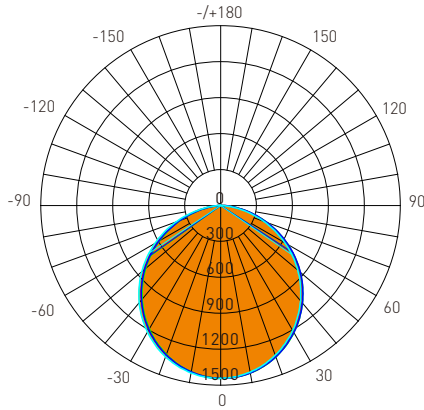

AVERAGE BEAM ANGLE(50%): 111.3°

Lumens: 4069.1 Lms
Watts: 39.05 W
LPW: 104.21 Lm/W
CCT: 3500K

UNIT: cd
 - C0/180, 110.8°
 - C30/210, 111.1°
 - C60/240, 111.6°
 - C90/270, 111.7°

Zonal Flux Diagram

τ	C0	C45	C90	C135	C180
10	1418	1421	1412	1398	1411
20	1340	1346	1331	1303	1327
30	1215	1225	1204	1164	1195
40	1049	1064	1038	988.4	1026
50	852.4	870.0	840.6	783.6	826.6
60	629.7	649.8	617.5	555.5	603.1
70	391.9	412.3	377.6	316.3	365.5
80	162.5	178.2	145.8	98.44	139.5
90	2.417	8.146	0.2768	0.4688	0.9405
100	0.5822	0.5917	0.6472	0.7610	0.6802
110	1.012	1.048	1.172	1.246	1.138
120	1.530	1.577	1.753	1.778	1.633
130	2.021	2.104	2.307	2.298	2.124
140	2.524	2.612	2.799	2.780	2.595
150	3.936	3.052	3.178	3.148	3.016
160	3.376	3.422	3.497	3.478	3.442
170	3.769	3.686	3.712	3.724	3.716
180	3.894	3.751	3.759	3.755	3.904
DEG	LUMINOUS INTENSITY:cd				

Zonal Lumens

τ	φ total
0-10	136.4
10-20	526.2
20-30	1115
30-40	1822
40-50	2553
50-60	3211
60-70	3708
70-80	3986
80-90	4058
90-100	4059
100-110	4060
110-120	4061
120-130	4063
130-140	4064
140-150	4066
150-160	4068
160-170	4069
170-180	4069
DEG	UNIT: lm

Luminance cd/(m2)

G(DEG)	C0/180	C90/270
85	10884	8777
80	13119	11617
75	14803	13683
70	16064	15274
65	16980	16310
60	17655	17084
55	18170	17649
50	18591	18090
45	18924	18435

4' / Regressed Lens / 3500K

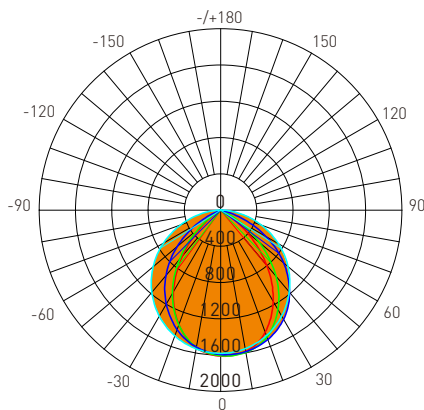

AVERAGE BEAM ANGLE(50%): 92.7°

Lumens: 3185.1 Lms
Watts: 39.18 W
LPW: 81.30 Lm/W
CCT: 3500K

UNIT: cd
 - C0/180, 75.9°
 - C30/210, 81.3°
 - C60/240, 98.3°
 - C90/270, 115.4°

Zonal Flux Diagram

τ	C0	C45	C90	C135	C180
10	1583	1593	1552	1494	1546
20	1434	1513	1475	1304	1347
30	1163	1339	1349	1044	1044
40	790.0	1073	1178	714.1	652.8
50	382.2	734.4	972.0	357.8	253.6
60	60.93	354.3	733.4	66.49	9.481
70	3.607	50.38	472.8	3.429	1.964
80	1.129	3.391	209.4	1.111	0.5673
90	0.2172	0.8545	0.4901	0.1488	0.1127
100	0.1263	0.1488	0.6813	0.2888	0.1309
110	0.1532	0.3044	1.232	0.7484	0.2482
120	0.4461	0.7326	1.867	1.429	0.6274
130	1.000	1.326	2.485	2.185	1.259
140	1.740	2.047	2.990	2.888	2.048
150	2.579	2.800	3.400	3.436	2.864
160	3.454	3.432	3.725	3.853	3.604
170	4.080	3.887	3.937	4.115	4.176
180	4.329	4.088	3.973	4.031	4.324
DEG	LUMINOUS INTENSITY:cd				

Zonal Lumens

τ	φ total
0-10	150.3
10-20	574.1
20-30	1189
30-40	1871
40-50	2474
50-60	2884
60-70	3092
70-80	3165
80-90	3176
90-100	3176
100-110	3177
110-120	3178
120-130	3179
130-140	3180
140-150	3182
150-160	3184
160-170	3185
170-180	3185
DEG	UNIT: lm

Luminance cd/(m2)

G(DEG)	C0/180	C90/270
85	91	14627
80	90	16749
75	110	18232
70	146	19198
65	212	19878
60	1692	20373
55	4751	20732
50	8259	21002
45	11457	21208

ZETA 2.3"-Surface Mount

Spec-grade | Architectural LED Linear Lighting



DISTRIBUTION DIAGRAM

4' / Louver / 4000K

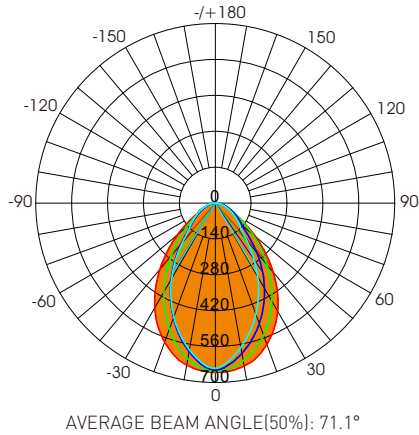

Lumens: 2851.01 Lm
Watts: 40 W
LPW: 72.74 Lm/W
CCT: 4000K

UNIT: cd
 - C0/180, 81.8°
 - C30/270, 74.5°
 - C60/240, 66.0°
 - C90/270, 62.1°

Zonal Flux Diagram

τ	C0	C45	C90	C135	C180
10	645.7	610.0	572.8	575.5	641.7
20	587.1	526.2	462.3	462.7	577.7
30	486.9	413.4	331.5	334.2	473.3
40	351.7	286.0	191.4	205.6	336.2
50	205.1	164.5	118.0	108.3	190.8
60	90.14	93.22	76.60	62.48	83.96
70	48.20	54.13	44.63	31.41	45.20
80	18.14	24.87	19.03	7.752	16.38
90	0.0943	2.294	0.0883	0.0823	0.0696
100	0.0964	0.1004	0.0997	0.1329	0.1092
110	0.1738	0.1566	0.1725	0.2238	0.1899
120	0.3161	0.2657	0.2690	0.3677	0.3403
130	0.5296	0.4396	0.4225	0.5662	0.5586
140	0.7842	0.6746	0.6471	0.8129	0.8181
150	1.061	0.9656	0.9161	1.073	1.087
160	1.341	1.250	1.209	1.318	1.338
170	1.532	1.462	1.427	1.492	1.541
180	1.601	1.541	1.498	1.507	1.609
DEG	LUMINOUS INTENSITY:cd				

Zonal Lumens

τ	φ total
0-10	59.69
10-20	217.7
20-30	427.4
30-40	632.8
40-50	788.8
50-60	891.2
60-70	954.3
70-80	987.8
80-90	997.0
90-100	997.3
100-110	997.4
110-120	997.7
120-130	998.0
130-140	998.4
140-150	999.0
150-160	999.5
160-170	999.9
170-180	1000
UNIT: lm	

Luminance cd/(m2)

G(DEG)	C0/180	C90/270
85	3109	3709
80	4137	4340
75	4858	4760
70	5581	5167
65	6368	5591
60	7139	6066
55	9642	6635
50	12635	7267
45	15571	7976

4' / Micro Reflector / 4000K

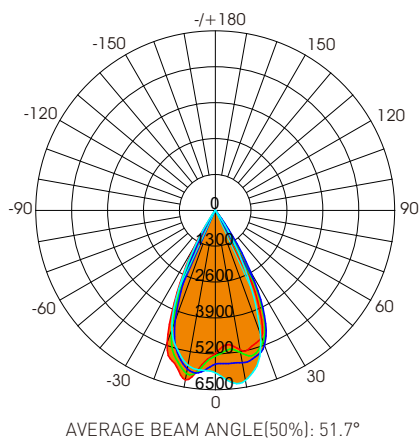

Lumens: 3840.82 Lm
Watts: 40 W
LPW: 99.09 Lm/W
CCT: 4000K

UNIT: cd
 - C0/180, 51.9°
 - C30/270, 52.6°
 - C60/240, 52.5°
 - C90/270, 49.7°

Zonal Flux Diagram

τ	C0	C45	C90	C135	C180
10	5120	5391	6262	6029	6239
20	4896	5241	4784	3135	5119
30	1657	2590	1455	264.5	1580
40	9.002	56.68	19.20	2.505	4.747
50	1.409	2.120	1.266	1.071	1.356
60	0.4646	0.7645	0.3787	0.3856	0.3831
70	0.3384	0.3652	0.3562	0.2976	0.2838
80	0.2346	0.3111	0.3337	0.2684	0.1577
90	0.1624	0.2953	0.2734	0.1060	0.0992
100	0.1218	0.1060	0.0812	0.1330	0.1264
110	0.1353	0.1128	0.1082	0.1330	0.1264
120	0.1443	0.1466	0.1443	0.1961	0.1578
130	0.2927	0.2661	0.4698	0.9288	0.3029
140	1.738	1.413	2.014	3.406	1.947
150	5.366	4.428	5.017	6.687	5.339
160	9.258	7.999	8.278	10.02	8.626
170	12.95	11.55	11.38	12.86	12.68
180	14.54	13.72	12.85	12.94	14.57
DEG	LUMINOUS INTENSITY:cd				

Zonal Lumens

τ	φ total
0-10	540.7
10-20	2029
20-30	3479
30-40	3822
40-50	3828
50-60	3829
60-70	3829
70-80	3830
80-90	3830
90-100	3830
100-110	3830
110-120	3830
120-130	3831
130-140	3831
140-150	3834
150-160	3837
160-170	3840
170-180	3841
UNIT: lm	

Luminance cd/(m2)

G(DEG)	C0/180	C90/270
85	31	47
80	19	27
75	15	19
70	14	14
65	13	12
60	13	11
55	18	15
50	30	27
45	43	52

ZETA 2.3"-Surface Mount

Spec-grade | Architectural LED Linear Lighting



DISTRIBUTION DIAGRAM

4' / Diffuser Wall Wash / 4000K

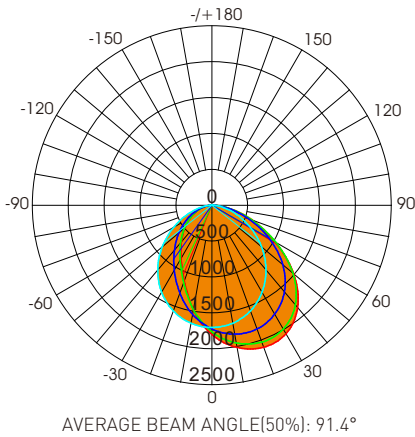

Lumens: 4602.1 Lm
Watts: 41.95 W
LPW: 109.71 Lm/W
CCT: 4000K

UNIT: cd
 - C0/180, 81.4°
 - C30/270, 85°
 - C60/240, 95.3°
 - C90/270, 103.8°

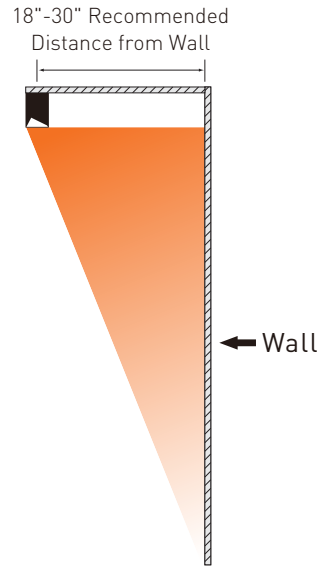

Zonal Flux Diagram

T	C0	C45	C90	C135	C180
10	2010	1892	1670	1472	1483
20	2106	1945	1568	1184	1126
30	2066	1891	1398	927.9	861.6
40	1860	1716	1174	715.0	661.5
50	1489	1408	904.0	528.6	494.0
60	1086	996.3	622.2	361.1	345.2
70	553.6	571.0	356.6	210.1	208.9
80	213.5	226.9	137.6	82.39	92.18
90	14.38	17.50	1.568	1.378	4.851
100	5.281	2.620	0.6399	0.9592	0.9344
110	1.389	0.8569	1.168	1.720	1.700
120	1.055	1.211	1.816	2.574	2.615
130	1.424	1.613	2.405	3.370	3.507
140	1.853	2.077	2.993	3.994	4.244
150	2.385	2.631	3.488	4.418	4.753
160	3.118	3.275	3.898	4.626	5.061
170	4.023	3.919	4.192	4.626	5.093
180	4.706	4.381	4.215	4.300	4.720
DEG	LUMINOUS INTENSITY:cd				

Zonal Lumens

T	φ total
0-10	163.5
10-20	625.8
20-30	1318
30-40	2145
40-50	2988
50-60	3717
60-70	4233
70-80	4509
80-90	4586
90-100	4590
100-110	4591
110-120	4593
120-130	4595
130-140	4597
140-150	4599
150-160	4061
160-170	4062
170-180	4062
	UNIT: lm

Luminance cd/(m2)

G(DEG)	C0/180	C90/270
85	14792	9050
80	17074	11003
75	19709	12753
70	22480	14479
65	25273	15947
60	28006	17283
55	30421	18643
50	32173	19532
45	33247	20509