

# COPA 3" DOWNLIGHT

For Retrofit or New Construction



Thanks to a unique low profile and small aperture design, it provides you with high quality, cost effective LED lighting in practically any space. Its broad compatibility simplifies the specification process making installing or replacing the light and trim fast and tool-free. 90+ CRI option, produces outstanding illumination at a tight chromaticity specification and color binning process to ensure CRI and CCT consistency.

It is best-in-class quality downlighting for retrofit or new construction applications. With industry-leading performance, it can provide a solution for any project - commercial, corporate and residential installations. Whatever your needs, there's a perfect match for your project.

## Features

- Quality - Powered by bridgelux high efficiency COB LED chip
- Flexibility - Split design of led light engine, lens, trim and driver, seamless integration
- Easy installation - Twist & Lock feature to connect all in a fast way
- Compatibility - Optional Flicker-free TRIAC/120V or 1-10V/100-277V
- True color - 90+ CRI, produces outstanding illumination



## PERFORMANCE

Model NO.	Input Power	Type	CRI	Lumen Output	Efficacy @ 3000K
CP3-10W-XXX	10W	IC	90+	850 LM	85 LM/W
CP3-18W-XXX	18W	NON-IC	90+	1620 LM	90 LM/W

All efficacy is ±5% base on different CCT. Check the IES file to gain the accurate data .



# COPA 3" DOWNLIGHT

For Retrofit or New Construction



## PRODUCT ORDERING GUIDE

Example: CP3-18W-30R

CP					
Product Series	Cutout Size	Wattage	CCT	LED Driver	
<b>CP</b> COPA Series	<b>3</b> 3" <b>QuickShip</b>	<b>10W</b> <b>QuickShip</b> 10 Watts	<b>30</b> <b>QuickShip</b> 3000K, 90+ CRI	<b>R</b> <b>QuickShip</b> Driver For Retrofit	
		<b>18W</b> <b>QuickShip</b> 18 Watts		<b>N</b> <b>QuickShip</b> Driver For New Construction	

## OPTIONAL ORDERING GUIDE

Trim Options	Beam Angle Options	Dimming Options	Optional Function
<b>RT</b> <b>QuickShip</b> Round Trim	<b>BM24</b> <b>QuickShip</b> 24°	<b>D10</b> <b>QuickShip</b> 1-10V (Dim to 10%) 100-277V AC	<b>EME</b> <b>QuickShip</b> Emergency Function (Only external 8w or 25w LED emergency driver with standard indicator available and need field-installed.)
<b>ST</b> <b>QuickShip</b> Square Trim	<b>BM36</b> <b>QuickShip</b> 36°	<b>TRA</b> <b>QuickShip</b> Triac / 120V AC	
<b>RTA</b> <b>QuickShip</b> Adjustable Round Trim	<b>BM60</b> <b>QuickShip</b> 60°		
<b>STA</b> <b>QuickShip</b> Adjustable Square Trim			



## STRUCTURE

### Optics

Classic reflector-like design provides high lighting transmittance. It effect in light control and anti-glare with side facula and fade-out facula. The MR16 standard size(diameter 1.96")design make them widely practical. Available in 24°, 36° and 60° beam angles.

### Electrical

**LED Driver** It is powered by Class 2 high efficiency 100-277V LED driver, with a standard 1-10V dimming which continuous dims to 10% that works with many types of controls. Tested Dimmers: Lutron® Diva-Dvtv, Leviton® IP-710-DL. Or optional 120VAC driver with Triac dimming is available. Thermal overload protection shuts down the luminaire when system temperatures exceed designed operating conditions

**THD** <20%  
**Power Factor** >0.9

### Approvals

- cULus listed for damp locations
- 5 years limited warranty

### Trim Finish

Powder coat white finish provides uniform finish providing long term performance and superior aesthetic.

### LED System

**CRI** 90+ color rendering index, producing outstanding illumination at a tight chromaticity specification and color binning process to ensure CRI and CCT consistency.

**CCT** 3000K, 4000K with a great color consistency.

**Thermal Management** Aluminum housing acting as the heat sink to maximize life. The temperature of all heatsinks are controlled at 60-70°C.

### Chip

Powered by bridgelux high efficiency COB LED chip.

### Mounting

Twist & Lock feature for easy trim installation. Durable tension clips are allowing for fast and easy flush installation.

# COPA 3" DOWNLIGHT

For Retrofit or New Construction



## ENGINE+OPTICS DIMENSION



## TRIM DIMENSION



Round Trim **RT**

Ø2.95"-3.03" Cutout

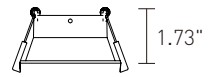
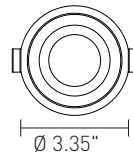

Square Trim **ST**

Ø2.95"-3.03" Cutout

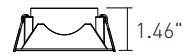
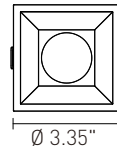

Adjustable Round Trim **RTA**

Ø2.83"-2.95" Cutout

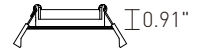
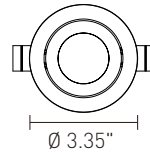

Adjustable Square Trim **STA**

Ø2.83"-2.95" Cutout

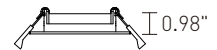
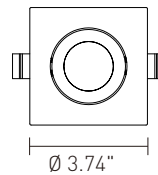

# COPA 3" DOWNLIGHT

For Retrofit or New Construction



## LED DRIVER BOX

LED Driver Box - Retrofit

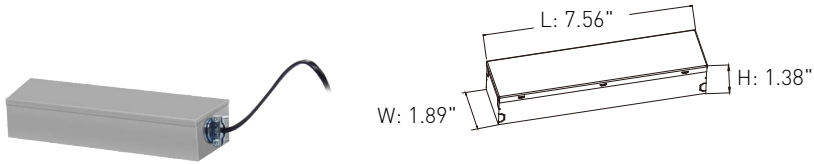

LED Driver Box - New Construction

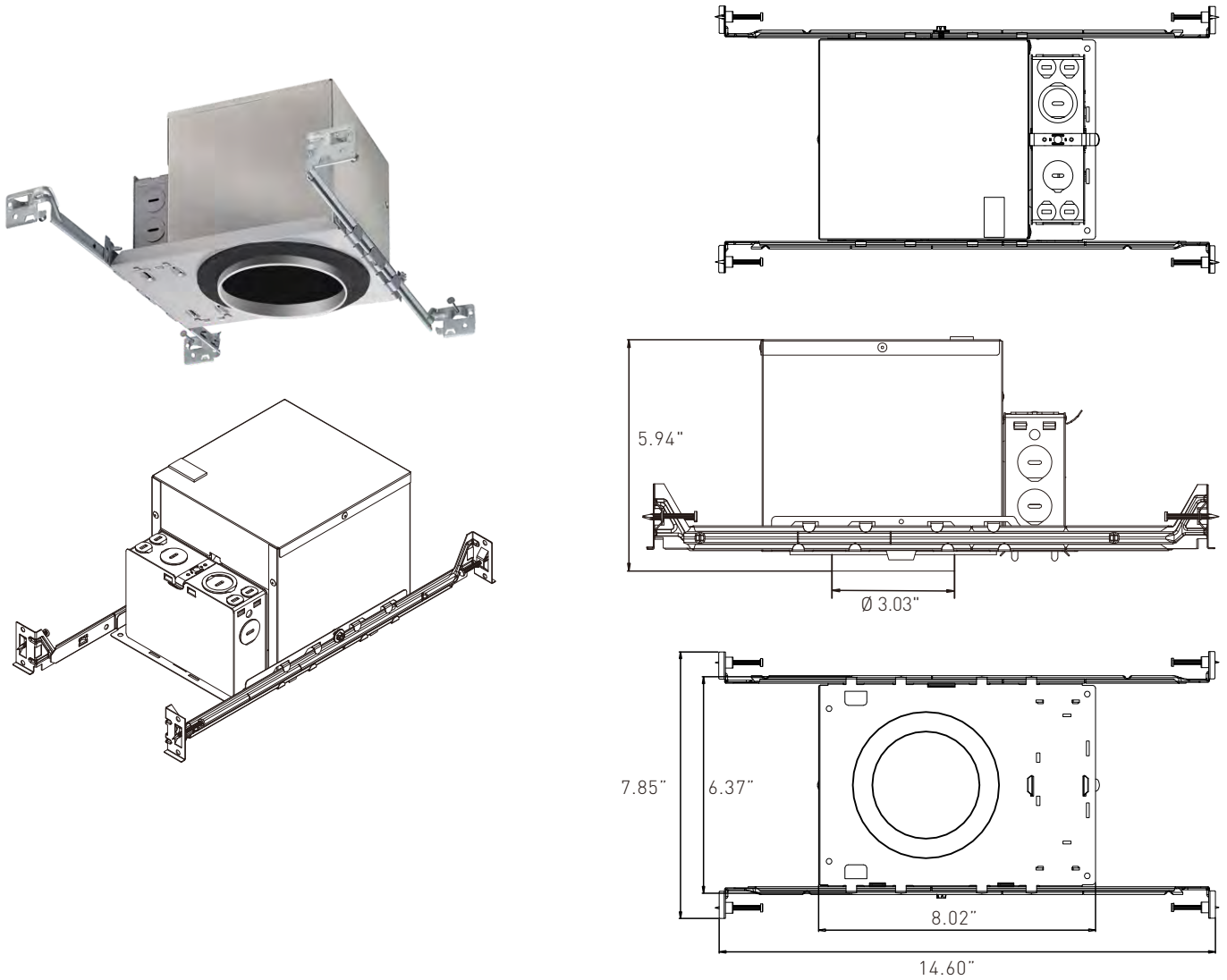

# COPA 3" DOWNLIGHT

For Retrofit or New Construction



## PHOTOMETRIC DIAGRAM

### 10W Downlight

24° -3000K

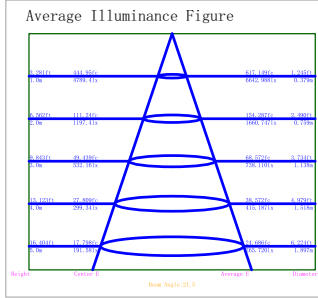
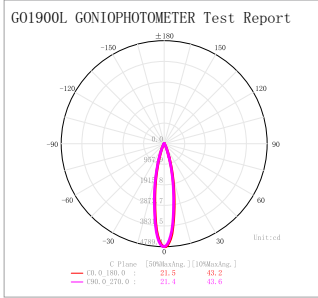

60° -3000K

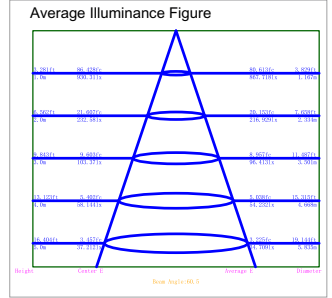
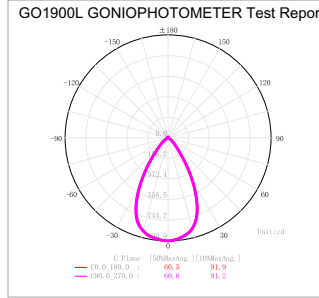

### 18W Downlight

24° -3000K

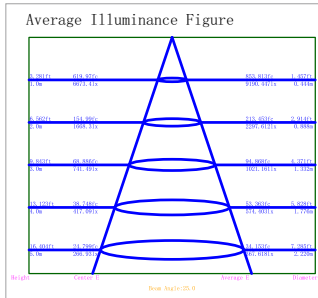
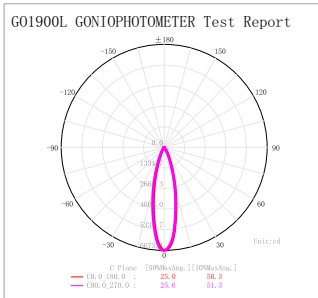

60° -3000K

