

⚠ RISK OF FIRE AND ELECTRICAL SHOCK. FIXTURE MUST BE INSTALLED BY A QUALIFIED ELECTRICIAN ONLY IN ACCORDANCE WITH NATIONAL, LOCAL BUILDING AND ELECTRICAL CODES. DISCONNECT POWER AT ELECTRICAL PANEL BEFORE SERVICING.

The product styles you received

First style: finished product with power cord

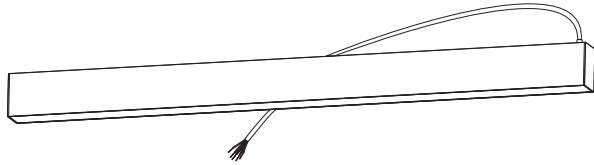

Second style: finished product with separate power cord



① Finished product without power cord

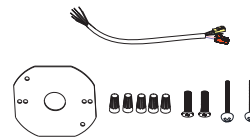

② Power cord kits

Third style: semi-finished product



① Housing



② Down led module



③ End caps

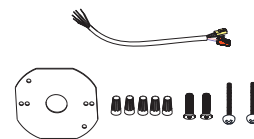

④ Power cord kits

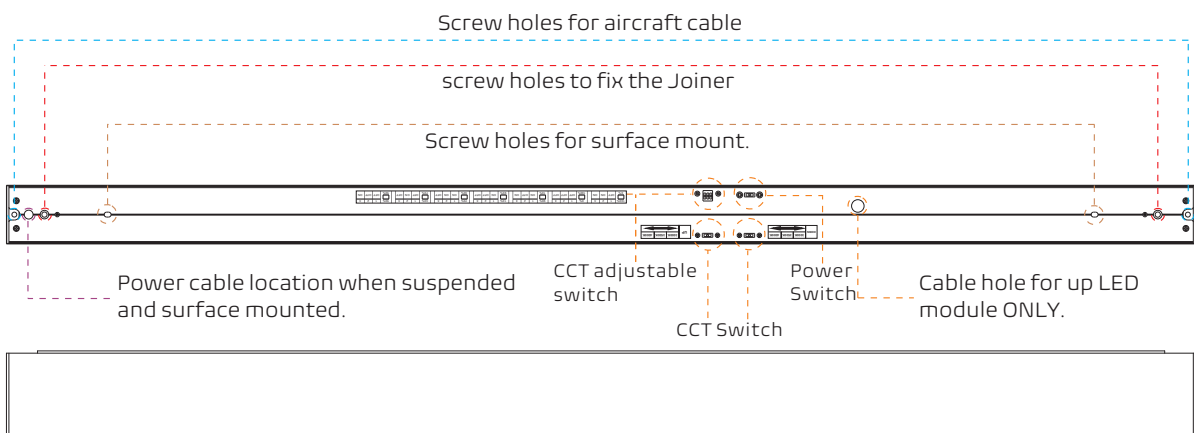

⚠ RISK OF FIRE AND ELECTRICAL SHOCK. FIXTURE MUST BE INSTALLED BY A QUALIFIED ELECTRICIAN ONLY IN ACCORDANCE WITH NATIONAL, LOCAL BUILDING AND ELECTRICAL CODES. DISCONNECT POWER AT ELECTRICAL PANEL BEFORE SERVICING.

IMPORTANT

1. Read all instructions.
2. Install in accordance with national and local electrical code regulations.
3. This product is intended to be installed and serviced by a qualified, licensed electrician.
4. Do not install in wet locations. For dry and damp use only.
5. Turn off electrical power before installing or servicing fixture in any way.
6. To reduce the risk of fire and overheating, make sure all connections are tight.
7. Under no circumstances can the lighting fixture be covered with heat insulation gasket or similar materials.
8. The maximum connection of each input line is 40FT(1200CM) in 120AC, 80FT(2400CM) in 230AC, 100FT(3000CM) in 277AC.

ACCESSORY

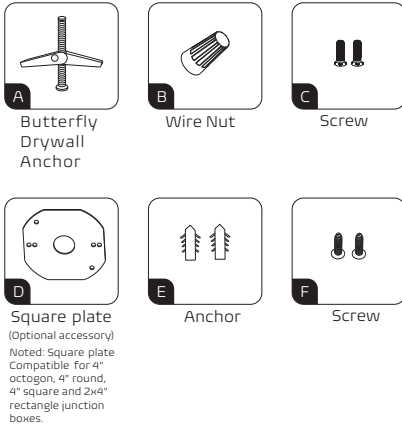

WIRING

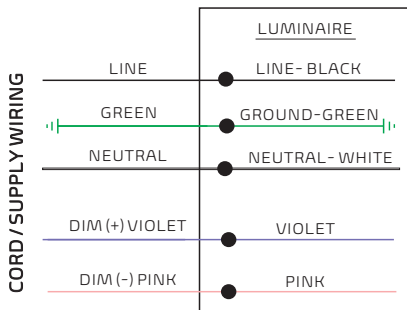

⚠ Please isolate two dimming wires by P2 terminal individually if no need dimming; MUST connect wires with corresponding colors as shown.

PRE-INSTALLATION

Assemble Power Cord

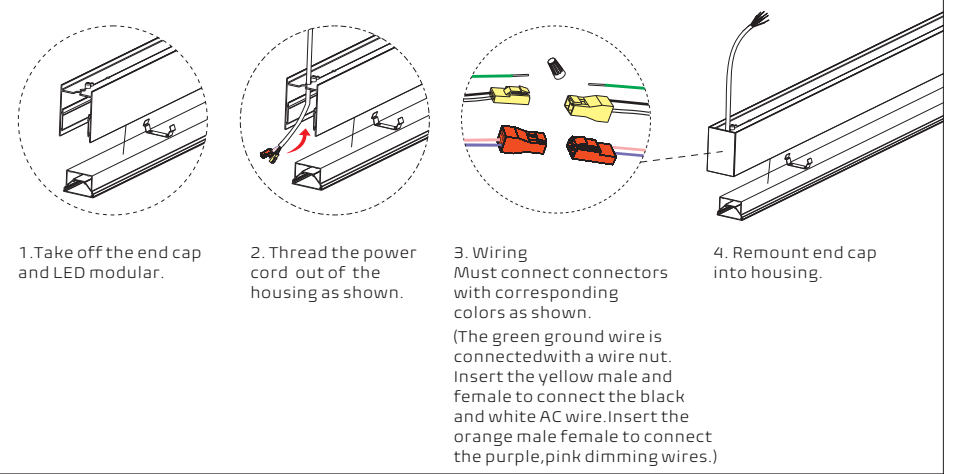

INDEPENDENT INSTALLATION

1 Prepare mounting point in the ceiling

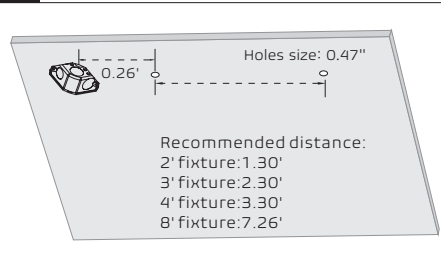

2 Mount plate and wiring

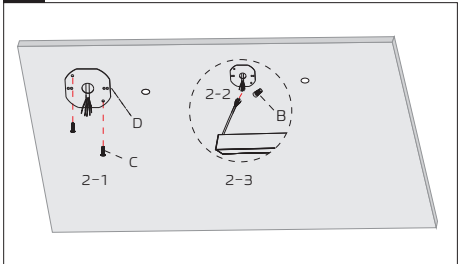

3 Screw the housing in the ceiling

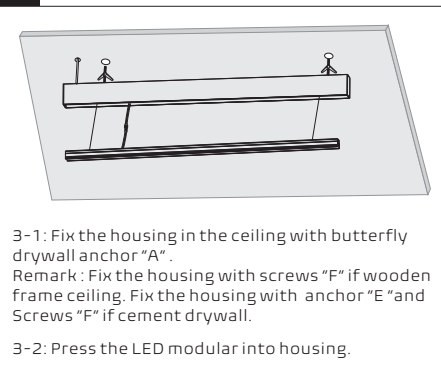

4 Complete

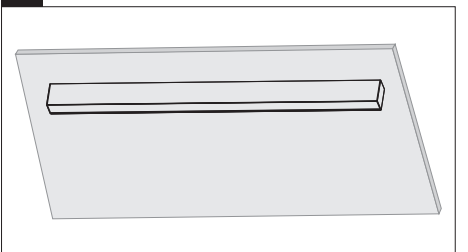

2.3" SURFACE LED

ARCHITECTURAL LED LUMINAIRE MULTIPLE LUMINAIRES CONNECTION

⚠ RISK OF FIRE AND ELECTRICAL SHOCK. FIXTURE MUST BE INSTALLED BY A QUALIFIED ELECTRICIAN ONLY IN ACCORDANCE WITH NATIONAL, LOCAL BUILDING AND ELECTRICAL CODES. DISCONNECT POWER AT ELECTRICAL PANEL BEFORE SERVICING.

JOINER OPTIONS

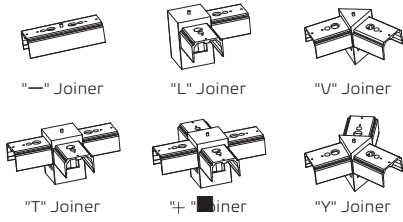

Noted: It needs 2 inputs if using joiner "T", "+ " and "Y".

LINE CONNECTION

1 Prepare mounting point in the ceiling

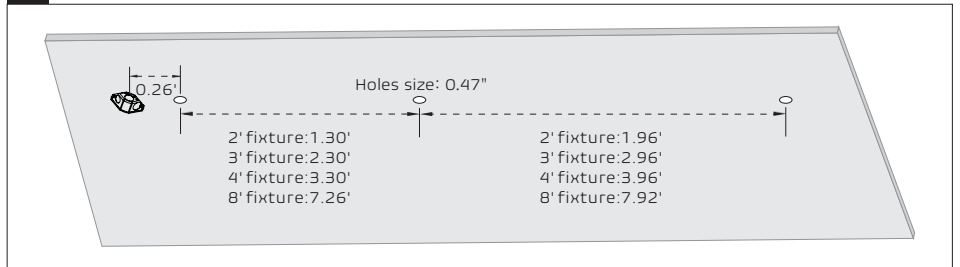

2 Mount plate and wiring

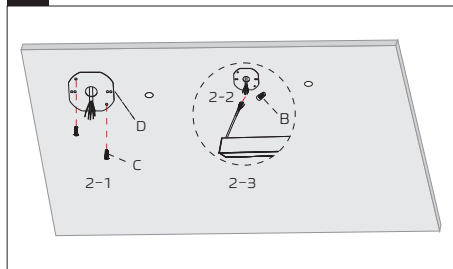

2-1: Cover the junction box with square plate "D" and fix it with screw "C", then plastering.
2-2: Then using the wire nut "B" to connect AC wires and dimming wires.
2-3: Hide all wires into the junction box.

3 Install the housing and joiner – SoR

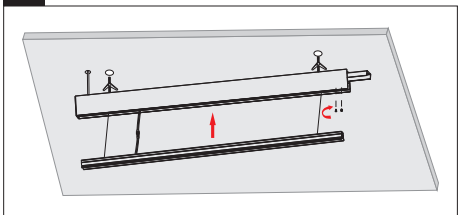

3-1: Fix the housing in the ceiling with butterfly drywall anchor "A".
Remark: Fix the housing with screws "F" if wooden frame ceiling. Fix the housing with Anchor "E" and Screws "F" if cement drywall.
3-2: Insert the joiner "—" into the SoR housing and fix it by screws.

4 Repeat install and join steps-MoR to EoR

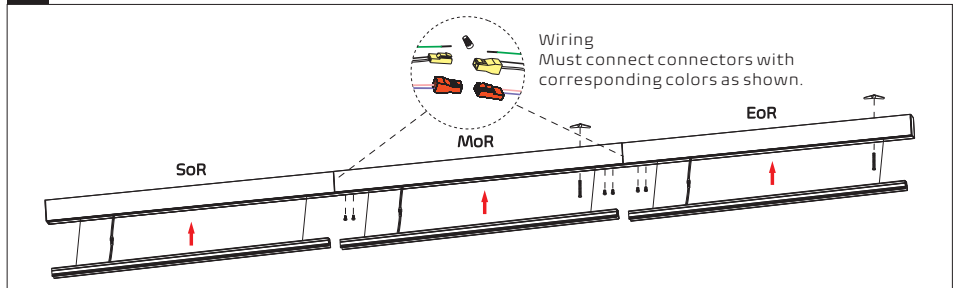

4-1: Fix the housing in the ceiling in turn.
4-2: Insert the joiner "—" into the housing and fix it by screws in turn.
4-3: Connect the quick connectors properly.
4-4: Insert all the led modules into the housing from SoR to EoR in turn.

5 Complete

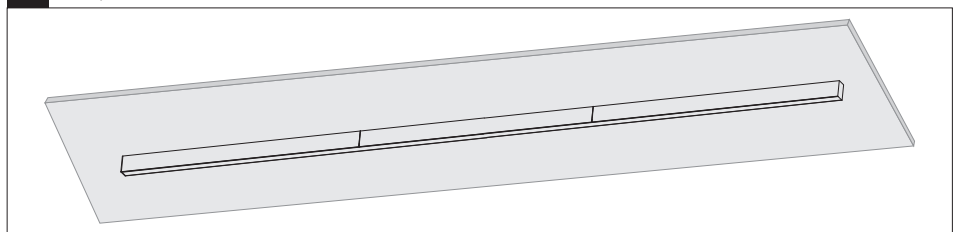

BEFORE CONNECTING

Disassemble Luminaires

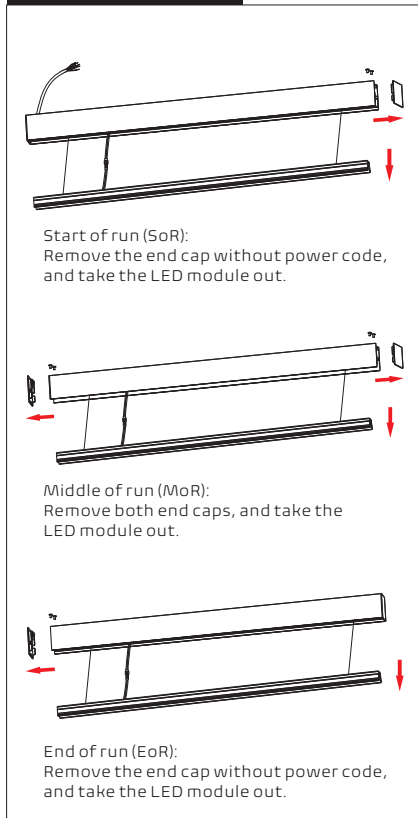

Optional 42' Diffuser Lens Roll

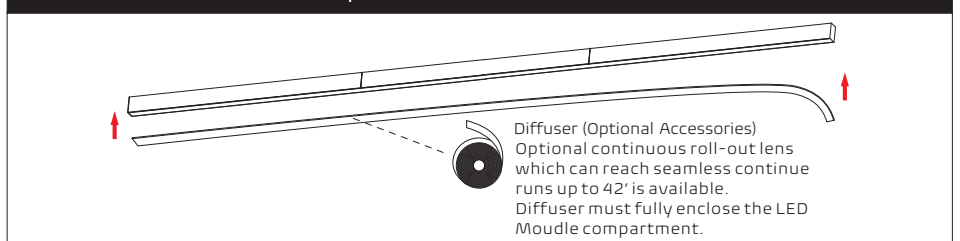

⚠ RISK OF FIRE AND ELECTRICAL SHOCK. FIXTURE MUST BE INSTALLED BY A QUALIFIED ELECTRICIAN ONLY IN ACCORDANCE WITH NATIONAL, LOCAL BUILDING AND ELECTRICAL CODES. DISCONNECT POWER AT ELECTRICAL PANEL BEFORE SERVICING.

L SHAPE CONNECTION

- ▲ For "T", "■", "Y", "V" shape or other geometric shapes, all subject to the "L" shape installation
- ▲ It needs 2 inputs if using joiner "T", "■" and "Y".

1 Make hole in the ceiling

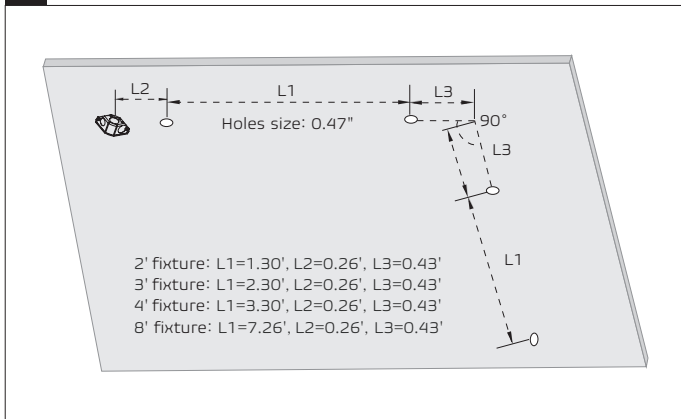

2 Mount plate and wiring

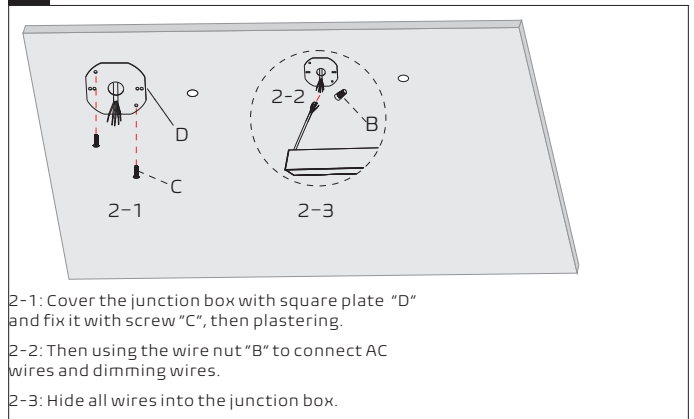

3 Install the housing and joiner – SoR

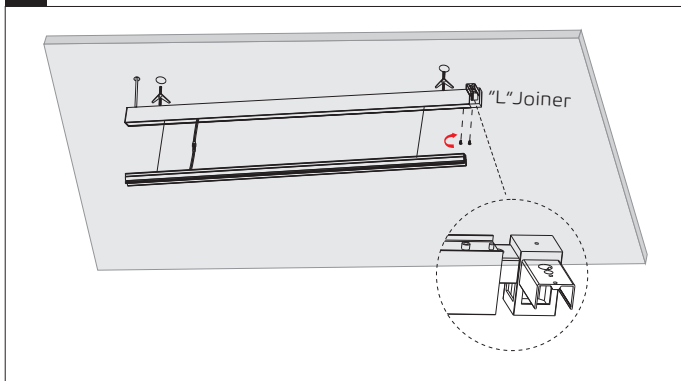

- 3-1: Fix the housing in the ceiling with butterfly drywall anchor "A"
 Remark: Fix the housing with screws "F" if wooden frame ceiling.
 Fix the housing with Anchor "E" and Screws "F" if cement drywall.
- 3-2: Insert the joiner "L" into the SoR housing and fix it by screws.

4

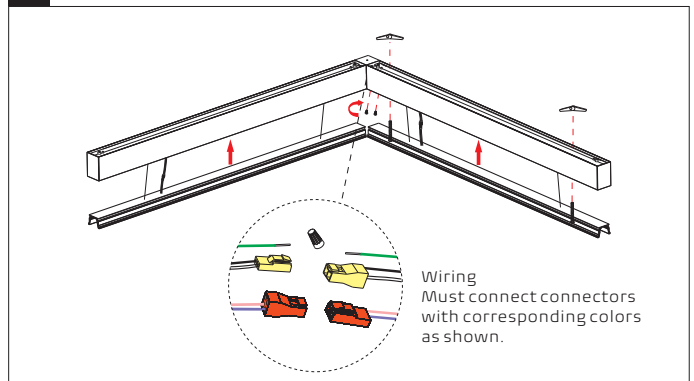

- 4-1: Fix the housing in the ceiling in turn.
 4-2: Insert the joiner "L" into the housing and fix it by screws in turn.
 4-3: Connect the quick connectors properly.
 4-4: Insert all the LED modules into the housing from SoR to EoR in turn.

5 Complete

