

# Slim Linear

Surface & Recessed | Architectural LED Linear



The revolutionary, sleek design of the LS is aesthetically pleasing to any space. It supports both surface and recessed mounts. It features popular 4", 6" width and 2', 4' length. Most of our customers have been struggling with inventory control, thanks to the wattage selectable and CCT adjustable technology, you can now fulfill more orders with fewer SKUs to win more projects! It works with most applications which will be your go-to-choice for offices, schools, hospital, corridor light industrial spaces or anywhere stylish lines of light are desired.



## Feature

- Ultra thin profile, only 0.94" thickness
- Built-in driver
- Available in 4", 6" width and 2', 4' length
- Wattage selectable (For 4ft)
- CCT adjustable from 3000K, 3500K and 4000K
- Available in surface mounted and recessed

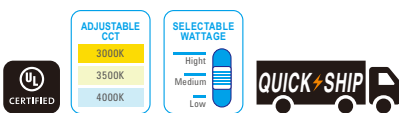

## PERFORMANCE

Width	Length	Wattage Selectable	Efficacy@4000K	Lumen@4000K
4inch	2ft	20W(Fixed)	80lm/w,800lm/ft	1600lm
	4ft	40W/30W/20W	80lm/w,800lm/ft	3200lm
6inch	2ft	20W(Fixed)	85lm/w,850lm/ft	1700lm
	4ft	40W/30W/20W	95lm/w,950lm/ft	3800lm

All efficacy is ±5% base on different CCT. Check the IES file to gain the accurate data .

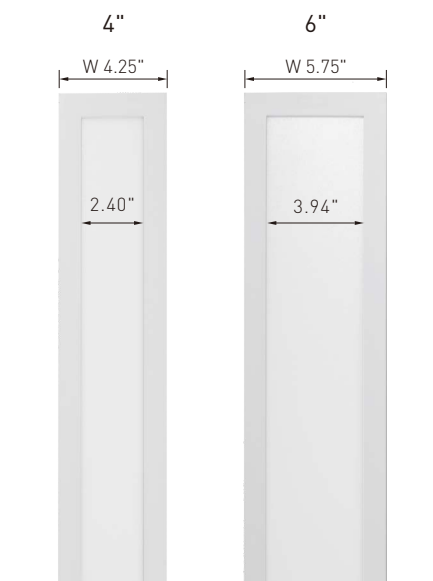

# Slim Linear

Surface & Recessed | Architectural LED Linear





## PRODUCT ORDERING GUIDE

Example: LS24-TWT

LS		TWT	
Product Series	Length	Width	CCT
<b>LS</b> Slim Surface Linear	<b>2</b> 2FT, 20W Up to 1600lm for 4inch width, 1700lm for 6inch width	<b>4</b> 4 inch	<b>TWT</b> CCT adjustable 3000K/3500K/4000K
	<b>4</b> 4FT, 40W/30W/20W Selectable Up to 3200lm for 4inch width, 3800lm for 6inch width	<b>6</b> 6 inch	

## OPTIONAL FUNCTIONS

Mounting Option	Optional Function
<b>SM</b> Surface-Surface Mounted Kit (Standard) This metal plate is equipped with screw holes for bolting to the ceiling, and 4 small static corner hooks on the mounting plate. 	<b>EME</b> Emergency Function (Only external 8w or 25w LED emergency driver with standard indicator available and need field-installed.) 
<b>RE</b> Recessed - Driver Box (Order Separated) This metal box is equipped with screw holes for bolting to the fixture to protect wires. 	

## PRODUCT PERFORMANCE

### Electrical

LED Driver	Internal driver makes it only 0.94" thickness
Dimming	Powered by high efficiency LED driver, with a standard 1-10V dimming which continuous dims to 10% that works with many types of controls. Tested Dimmers: Lutron @ Diva-Dvtv, Leviton @ IP-710-DL.
THD	<20%
Power Factor	>0.9
Input Voltage	Standard electronic driver is UL recognized and available for 110-277V or 110-347V AC*.

### LED System

CRI	Minimum 80 color rendering index
CCT	CCT adjustable from 3000K, 3500K and 4000K with a great color consistency.
LED	life Minimum 50,000h with 87.8% of lumen maintenance in 25°C ambient temperature, in compliance with IES LM-80 testing measurements.
Thermal Management	Aluminum housing acting as the heat sink to maximize life.

### Construction

Extruded aluminum housing.

### Approvals

- cULus listed for damp locations
- 5-year Limited Warranty

## DIMENSION

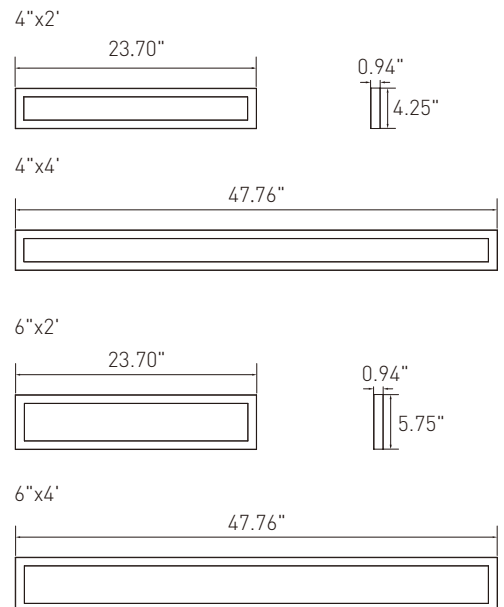

\*Additional cost and/or lead time on customized fixtures may apply. Some fixtures require an MOQ. Please contact your sales rep for more information.

# Slim Linear

Surface & Recessed | Architectural LED Linear



## DISTRIBUTION DIAGRAM

4"x4'

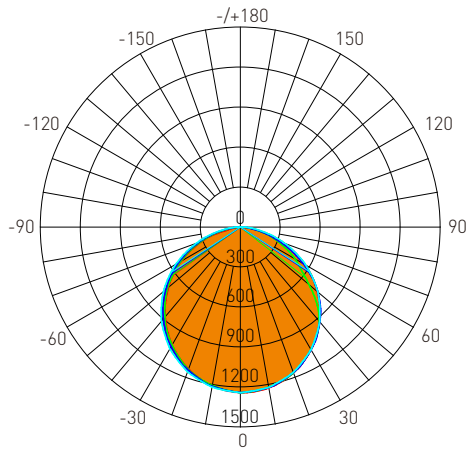

AVERAGE BEAM ANGLE(50%): 111.2°

Lumens: 3773.4 Lm  
Watts: 40 W  
LPW: 94.34 Lm/W  
CCT: 4000K

UNIT:cd  
— C0/180,111.5°  
— C30/210,106.9°  
— C60/240,112.4°  
— C90/270,114.0°

Zonal Flux Diagram

τ	C0	C45	C90	C135	C180
5	1161	1157	1158	1158	1162
10	1144	1142	1149	1143	1145
15	1116	1119	1121	1121	1118
20	1079	1081	1092	1082	1081
25	1034	1040	1046	1039	1035
30	979.6	987.7	999.2	975.3	979.5
35	917.4	926.8	936.4	896.2	915.6
40	848.0	861.8	873.5	814.1	844.4
45	772.4	773.0	796.0	700.0	765.8
50	690.2	658.7	718.5	566.7	681.2
55	603.1	539.1	628.2	454.6	590.0
60	510.9	441.1	537.9	362.9	494.5
65	411.5	356.9	438.3	285.2	393.4
70	309.9	269.0	338.8	209.2	288.9
75	201.6	185.0	240.6	136.6	170.1
80	112.0	107.5	142.4	75.01	50.70
85	25.08	46.18	73.35	29.85	9.004
90	1.375	4.618	4.269	2.435	0.4506

Zonal Lumens

τ	φ total
0-5	27.77
5-10	110.1
10-15	244.1
15-20	425.3
20-25	647.4
25-30	902.8
30-35	1183
35-40	1477
40-45	1777
45-50	2067
50-55	2338
55-60	2580
60-65	2788
65-70	2955
70-75	3078
75-80	3158
80-85	3198
85-90	3211

Luminance cd/(m2)

G(DEG)	C0/180	C90/270
85	3986	11657
80	8930	11361
75	10786	12876
70	12551	13720
65	13486	14365
60	14153	14899
55	14562	15169
50	14873	15483
45	15129	15592

6"x4'

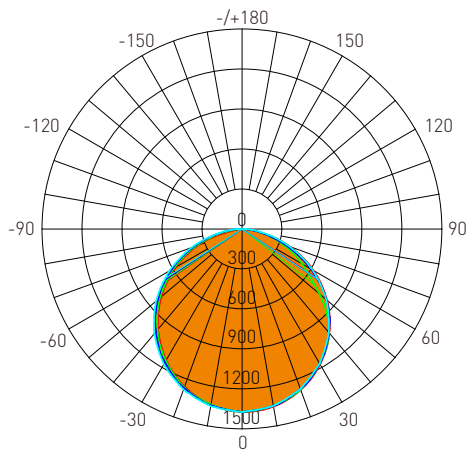

AVERAGE BEAM ANGLE(50%): 111.5°

Lumens: 3869.8 Lm  
Watts: 40 W  
LPW: 96.75 Lm/W  
CCT: 4000K

UNIT:cd  
— C0/180,111.7°  
— C30/210,108.0°  
— C60/240,112.7°  
— C90/270,113.7°

Zonal Flux Diagram

τ	C0	C45	C90	C135	C180
5	1386	1382	1383	1384	1389
10	1366	1364	1372	1367	1370
15	1333	1336	1338	1341	1339
20	1289	1291	1304	1295	1295
25	1234	1241	1248	1244	1240
30	1170	1178	1192	1180	1174
35	1096	1105	1116	1105	1098
40	1014	1027	1041	1019	1012
45	924.1	926.5	947.5	879.8	918.3
50	826.7	806.0	854.3	720.4	817.1
55	723.2	665.0	745.9	582.6	708.4
60	613.7	540.6	637.4	463.8	594.0
65	496.7	434.4	518.5	363.1	474.2
70	376.5	328.5	399.5	268.3	350.8
75	250.2	223.0	283.5	177.4	214.9
80	135.1	128.5	167.4	99.54	68.68
85	29.57	54.04	85.37	40.78	18.34
90	0.7982	4.035	3.376	2.877	0.4350

Zonal Lumens

τ	φ total
0-5	33.18
5-10	131.5
10-15	291.7
15-20	508.1
20-25	773.7
25-30	1079
30-35	1415
35-40	1769
40-45	2128
45-50	2478
50-55	2806
55-60	3099
60-65	3351
65-70	3554
70-75	3706
75-80	3804
80-85	3854
85-90	3870

Luminance cd/(m2)

G(DEG)	C0/180	C90/270
85	2924	8444
80	6708	8309
75	8333	9441
70	9489	10070
65	10132	10576
60	10581	10990
55	10870	11210
50	11087	11458
45	11267	11552